

43028

Figure 1-1. Starboard Side

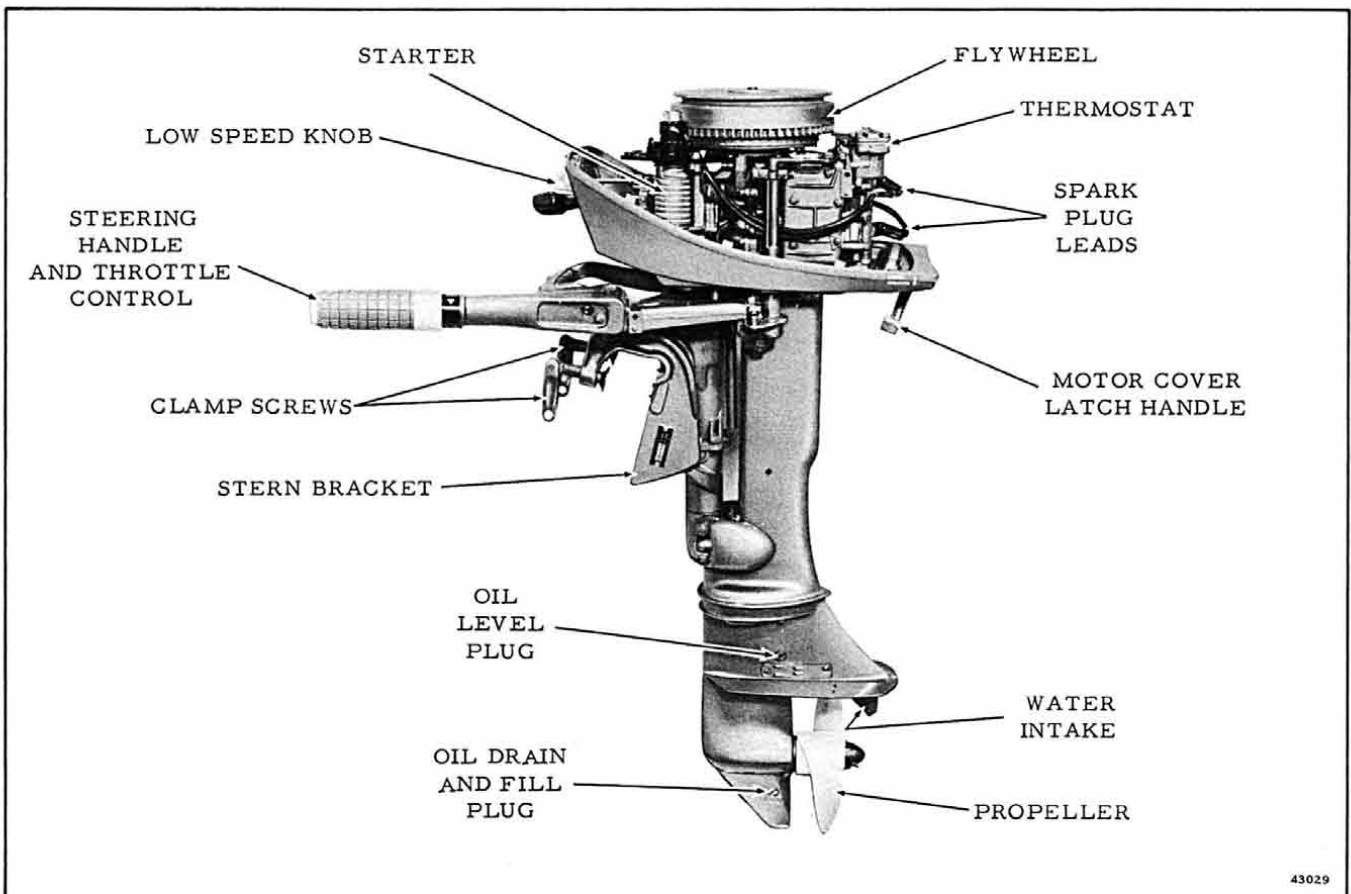

43029

Figure 1-2. Port Side